

Specification

80W/120W/160W/240W/300W/450W/600W available

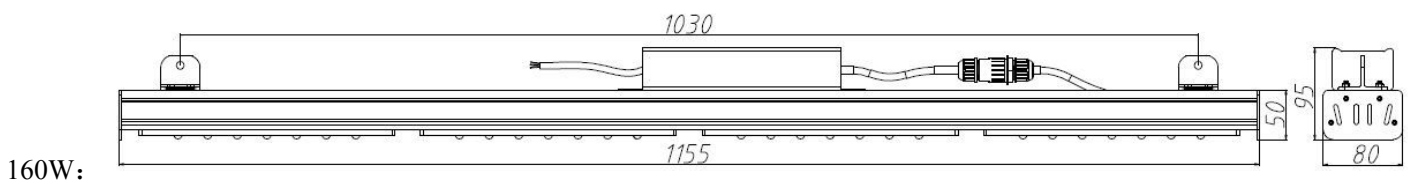

Specification

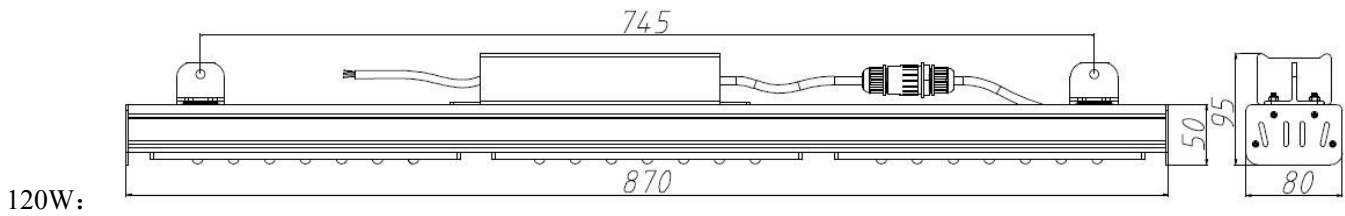
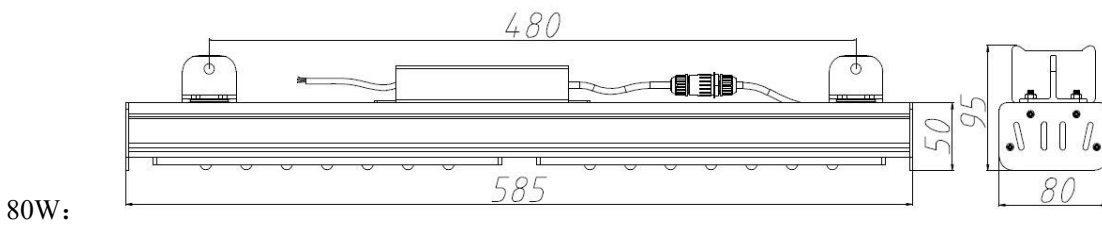
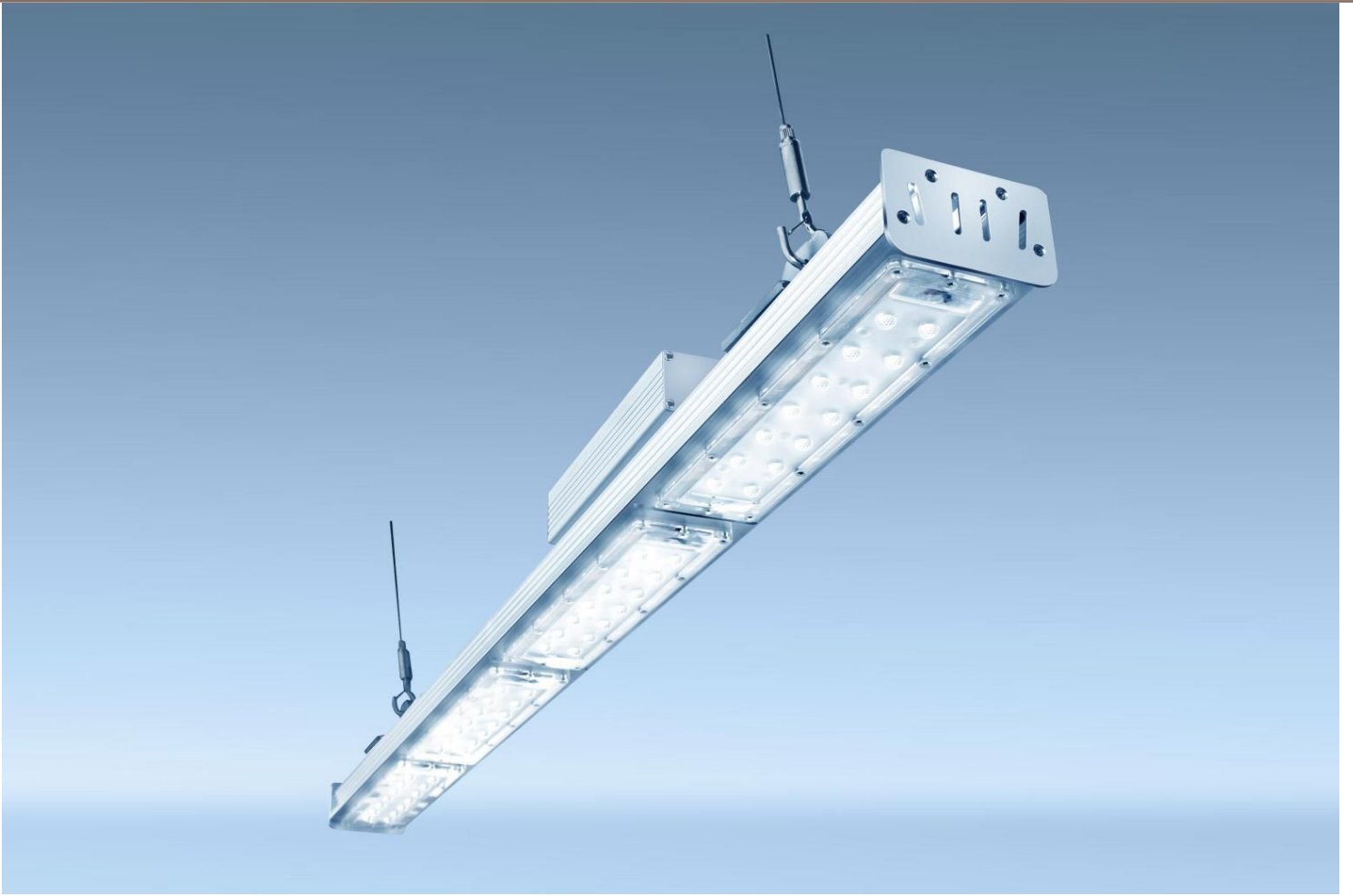

Specification

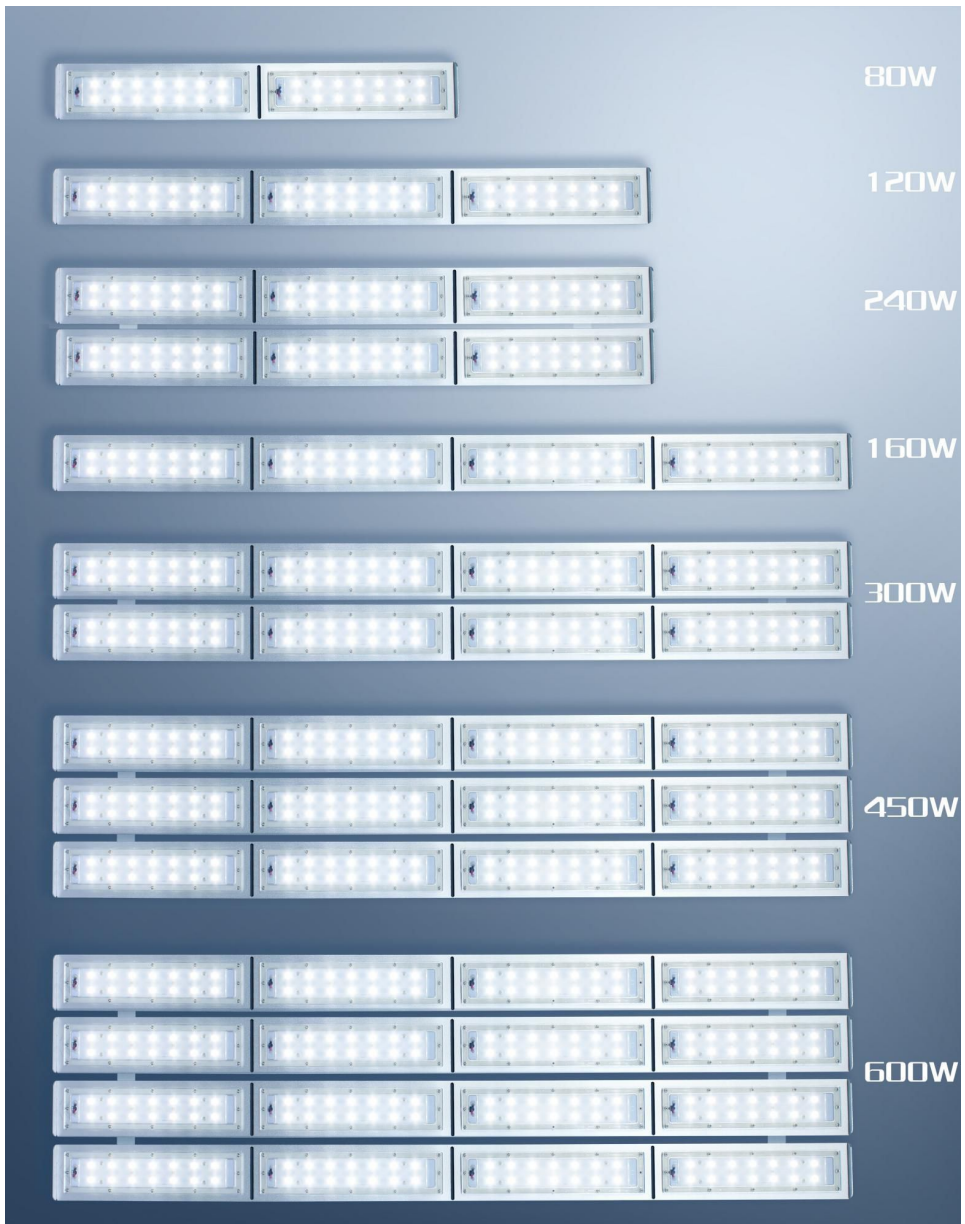
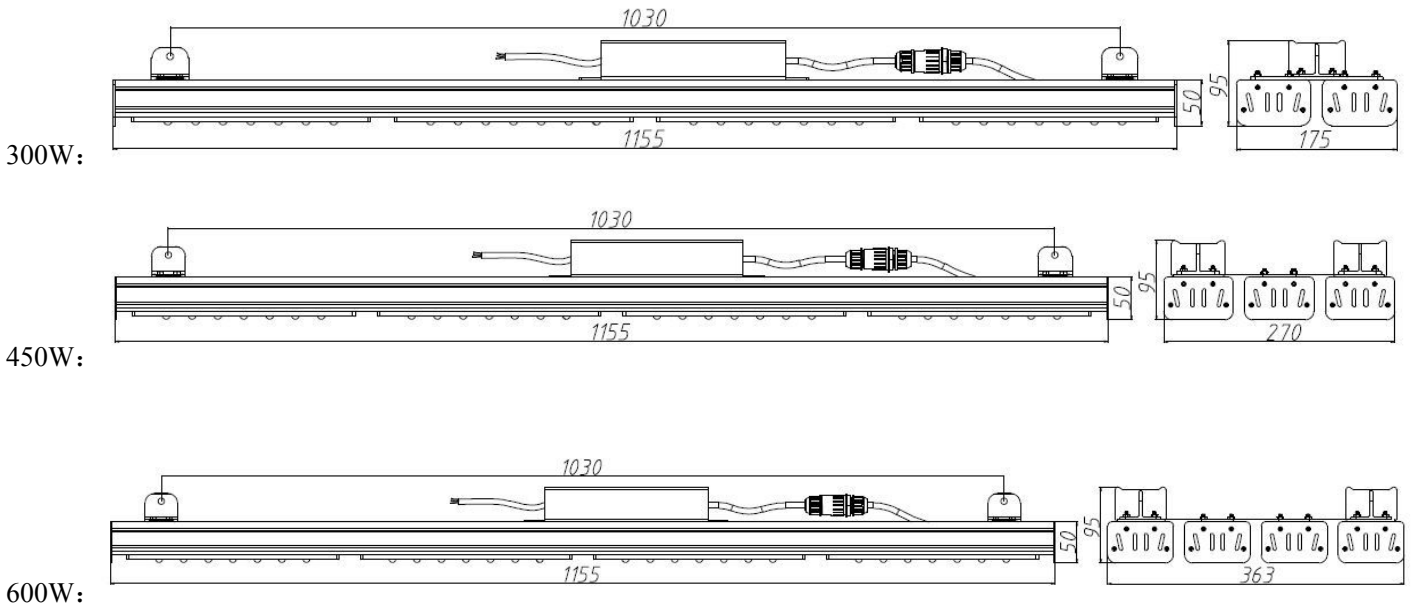

Specification

---

## Module Highbay



Specification:

---

Low light decrease: Samsung/SEOUL high power LED (Max. 5W per LED), only 50% 2.5W is used in this module high bay.

Brilliant heat dissipation performance and robust structure improve the durability of luminaires.

Strong, safe and easy installation.

5 year warranty

Suitable for 10 to 30 meters height

Powerful Lux as high as 1131lx at 20 meters high 300W

IP65, corrosion-proof, water-proof and dust-proof

40 and 80 degree beam angel options

High power option: 80W, 120W, 160W, 240W,300W,450W,600W

High power LED SMD3535, less light decrease

Very low UGR (Unified Glare Rating)

Maintenance free: high quality Meanwell Driver,1-10V and DALI dimmable available

**Specification**

Model No.	OB-MHB-SMD-80W-600mm-IP65	OB-MHB-SMD-120W-900mm-IP65	OB-MHB-SMD-160W-1200mm-IP65	OB-MHB-SMD-240W-900mm-IP65	OB-MHB-SMD-300W-1200mm-IP65
Size	585*80*95mm	870*80*95mm	1155*80*95mm	870*80*95mm	1155*180*95mm
Rated Power	80W	120W	160W	240W	300W
Input Voltage	AC100-240V, 50~60Hz	AC100-240V, 50~60Hz	AC100-240V, 50~60Hz	AC100-240V, 50~60Hz	AC100-240V, 50~60Hz
LED Quantity	28pcs SEOUL3535	42pcs SEOUL3535	56pcs SEOUL3535	84pcs SEOUL3535	112pcs SEOUL3535
Color Temperature	3000K-3500K/4000K-4500K/5500K-6500K	3000K-3500K/4000K-4500K/5500K-6500K	3000K-3500K/4000K-4500K/5500K-6500K	3000K-3500K/4000K-4500K/5500K-6500K	3000K-3500K/4000K-4500K/5500K-6500K
Luminous flux	7000-8500LM	11000-12500LM	15000-16500LM	23000-25000LM	29000-32000LM
CRI	>80	>80	>80	>80	>80
Materials	Aluminum & PC Cover	Aluminum & PC Cover	Aluminum & PC Cover	Aluminum & PC Cover	Aluminum & PC Cover
Beam Angle	40°	40°	40°	40°	40°
IP Grade	IP65	IP65	IP65	IP65	IP65
Package	14.2kg/4pcs/Carton	18.8kg/4pcs/Carton	23.8kg/4pcs/Carton	10.5kg/1pcs/Carton	24.5kg/2pcs/Carton
Carton size	650*340*120mm	930*340*120mm	1210*340*120mm	925*220*130mm	1210*420*130mm
Net weight	3kg	4kg	5kg	8.3kg	10.3kg
Warranty	5 years	5 years	5 years	5 years	5 years

Specification

Technical information:

**OB-MHB-SMD-80W-600mm-IP65**

Color Temperature	Power	Height (m)	Lux value
4000K	80W	5m	510lx
		6m	345lx
		8m	200lx
		10m	128lx
6000K	80W	5m	540lx
		6m	375lx
		8m	212lx
		10m	135lx



**OB-MHB-SMD-120W-900mm-IP65**

Color Temperature	Power	Height (m)	Lux value
4000K	120W	5m	802lx
		8m	313lx
		10m	200lx
		12m	140lx
6000K	120W	5m	870lx
		8m	340lx
		10m	217lx
		12m	151lx





Specification

**OB-MHB-SMD-160W-1200mm-IP65**

Color Temperature	Power	Height (m)	Lux value
4000K	160W	8m	419lx
		10m	268lx
		12m	186lx
		14m	137lx
6000K	160W	8m	450lx
		10m	288lx
		12m	200lx
		14m	147lx

**Photometric data:**

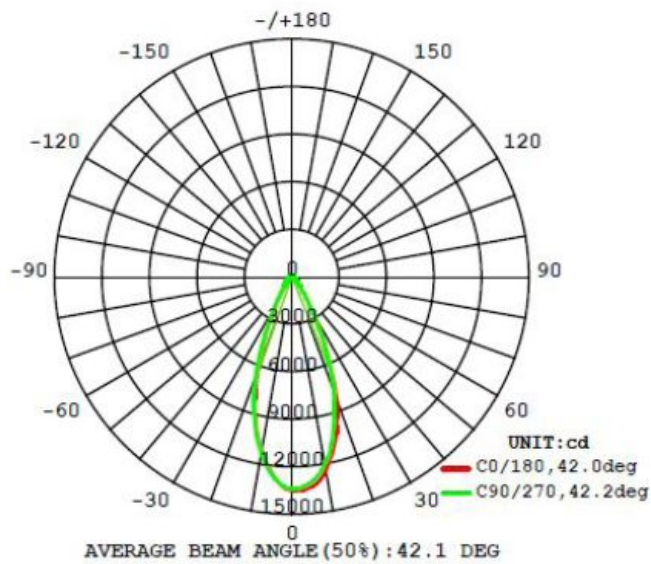

**80W CW 40°**

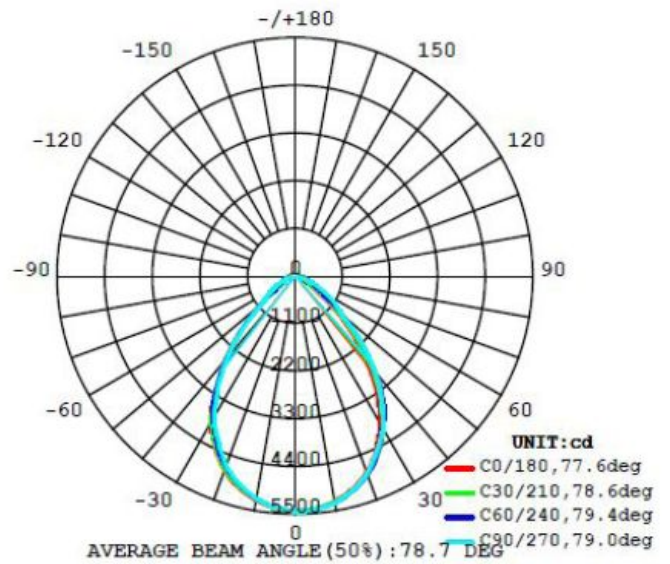

**80W CW 80°**

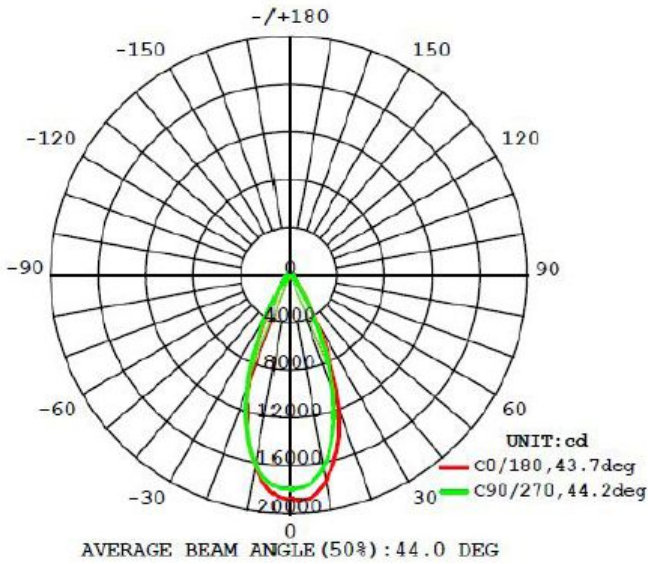

120W CW 40°

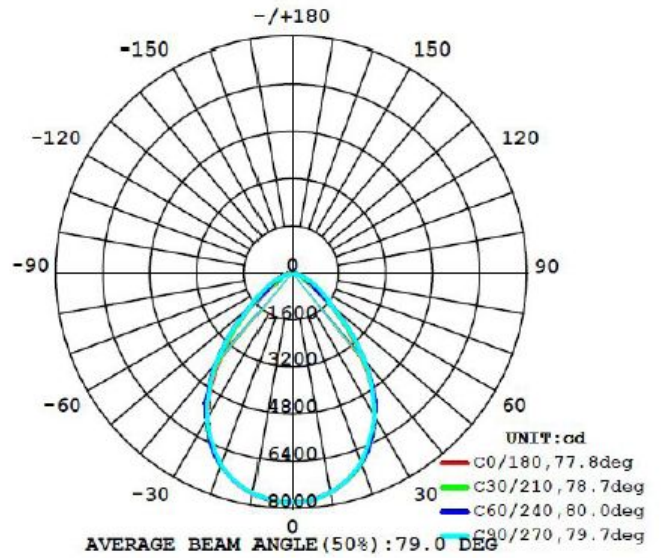

120W CW 80°

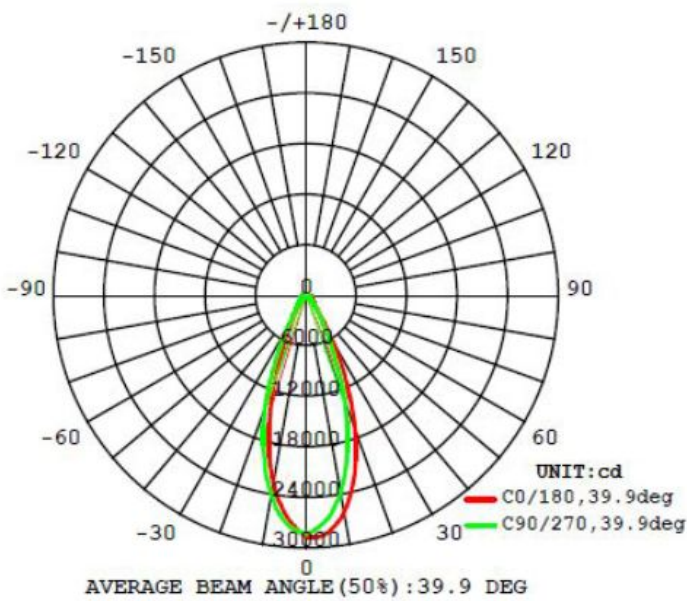

160W CW 40°

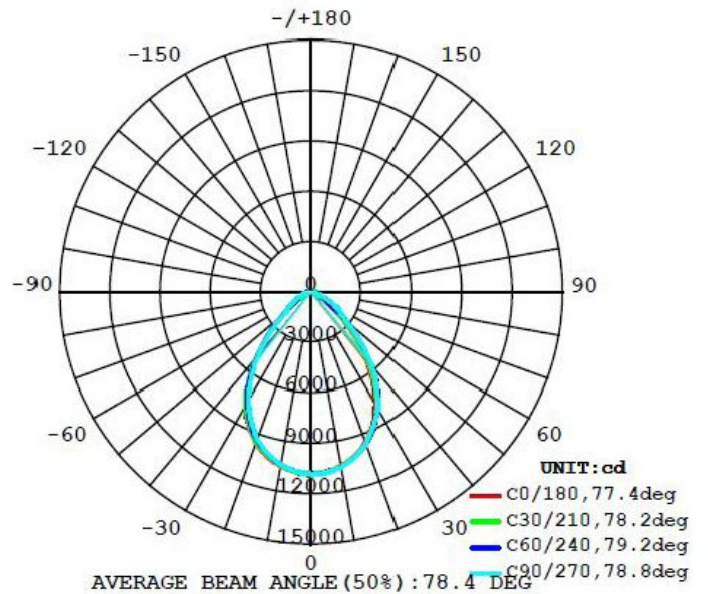

160W CW 80°



Specification

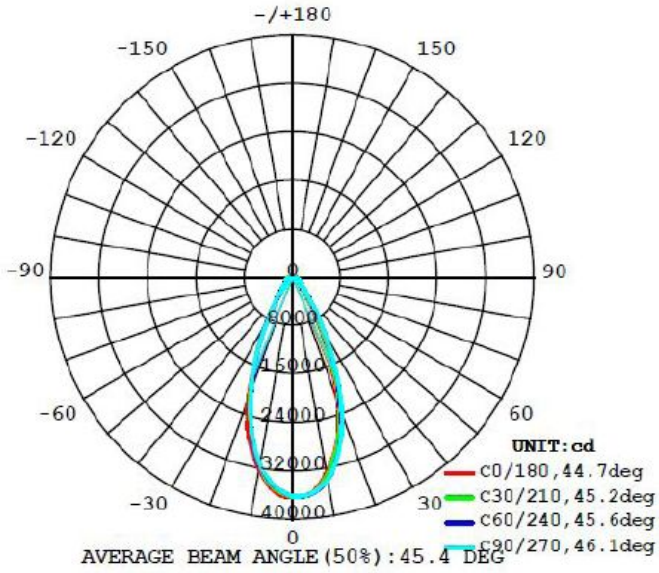

240W CW 40°

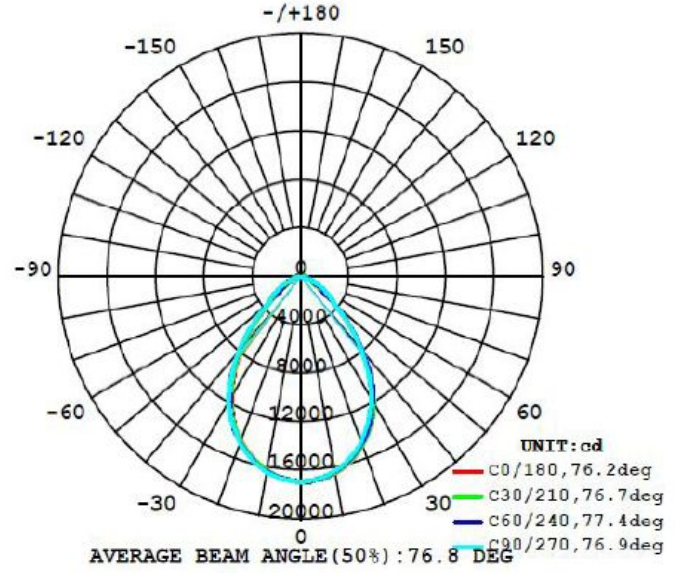

240W CW 80°

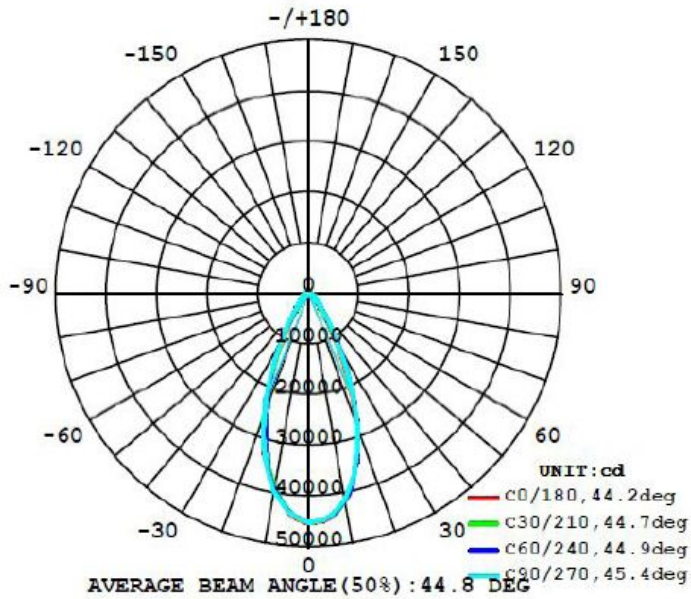

300W CW 40°

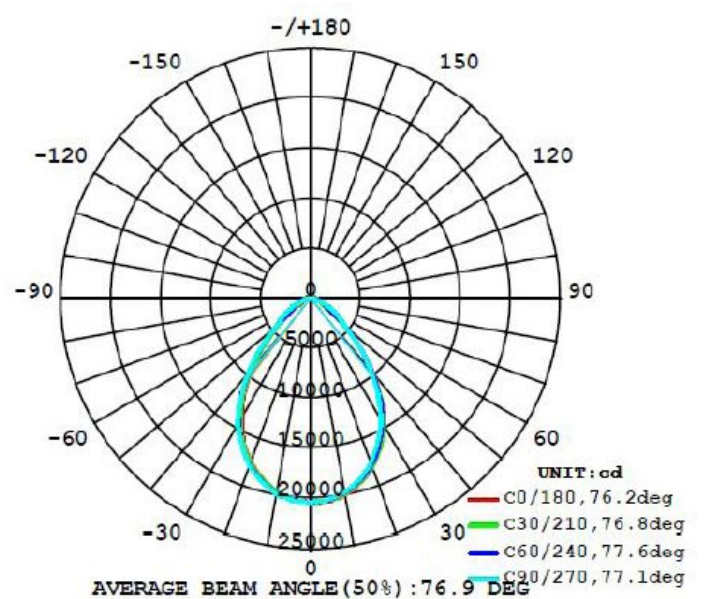

300W CW 80°

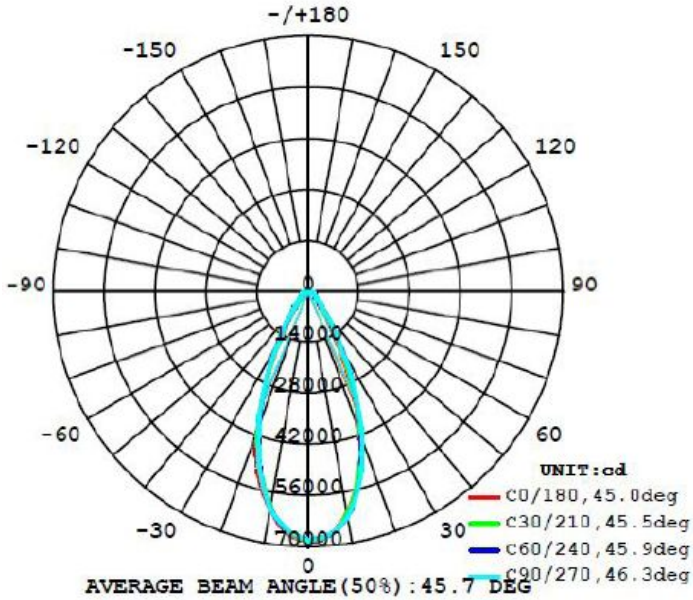

450W CW 40°

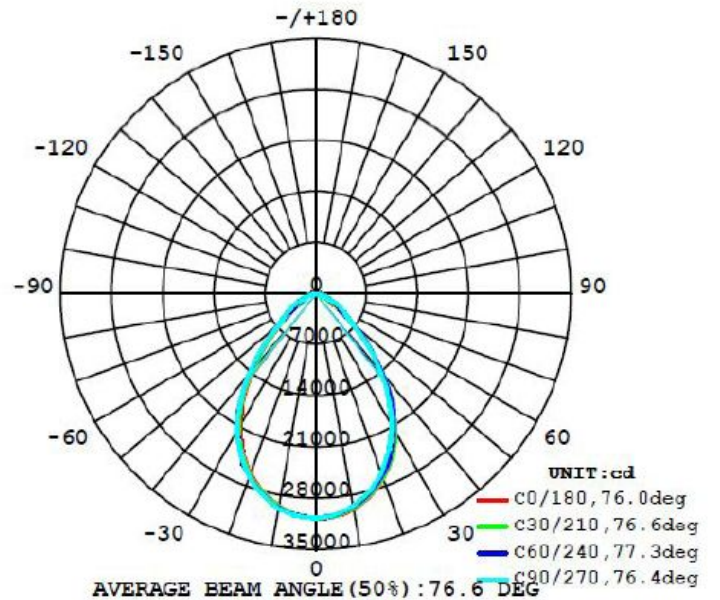

450W CW 80°

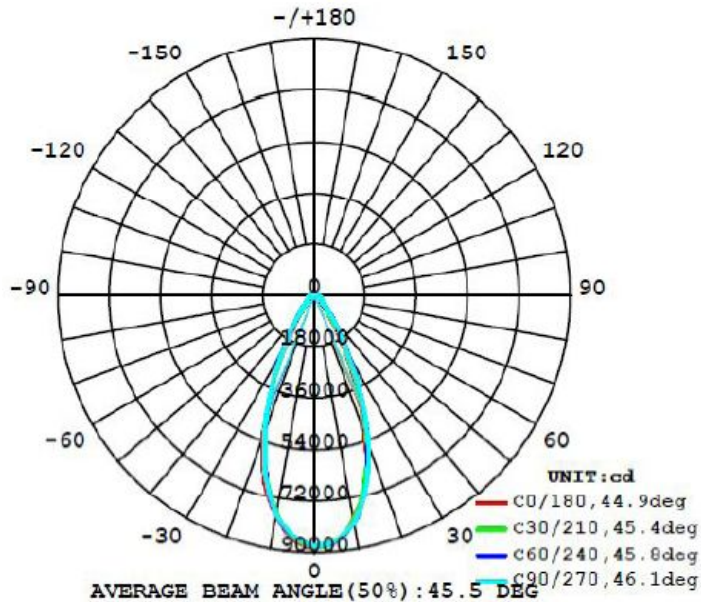

600W CW 40°

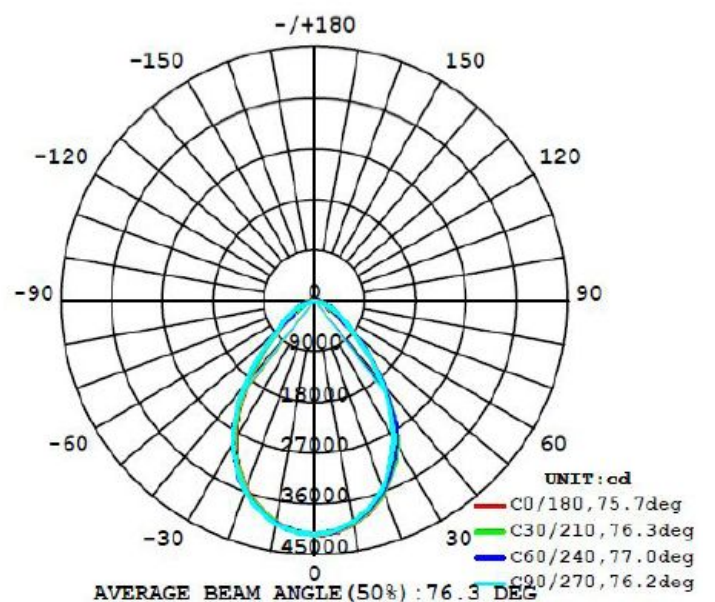

600W CW 80°



Suspending Ropes Installation

**Step1: Adjust the interval space according to actual situation.**

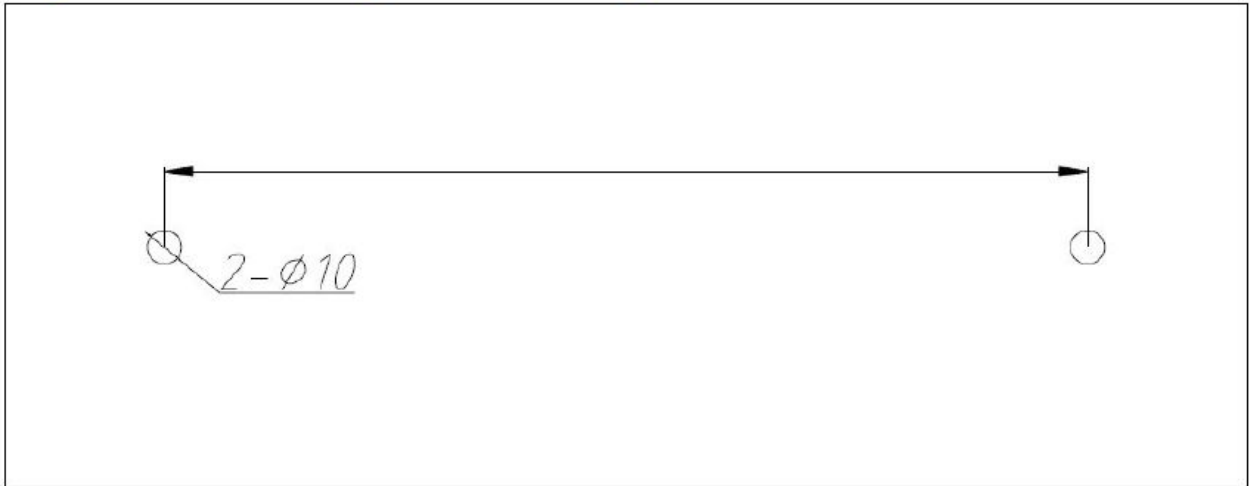

**Step2: Fix the expansion screws in the wall.**

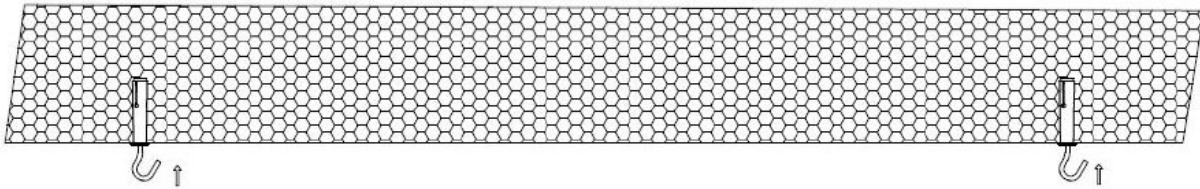

**Step3:**

**A: Hang the lifting ropes on the clivers of the expansion screws.**

**B: Press on the upper buttons to adjust the height of the lifting ropes.**

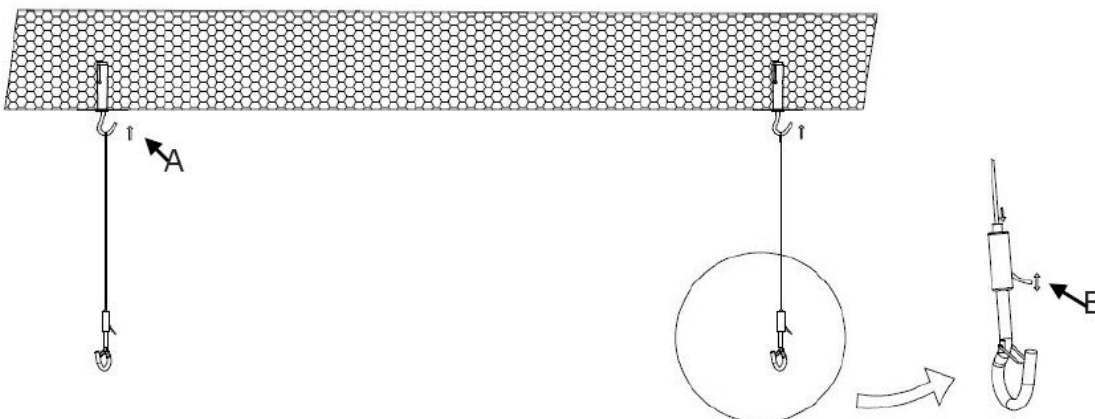

Specification

---

**Step4: Install the rings, and lock the nut tightly with the wrench.**



**Step5: Hang the lamp on the hook of the rope.**

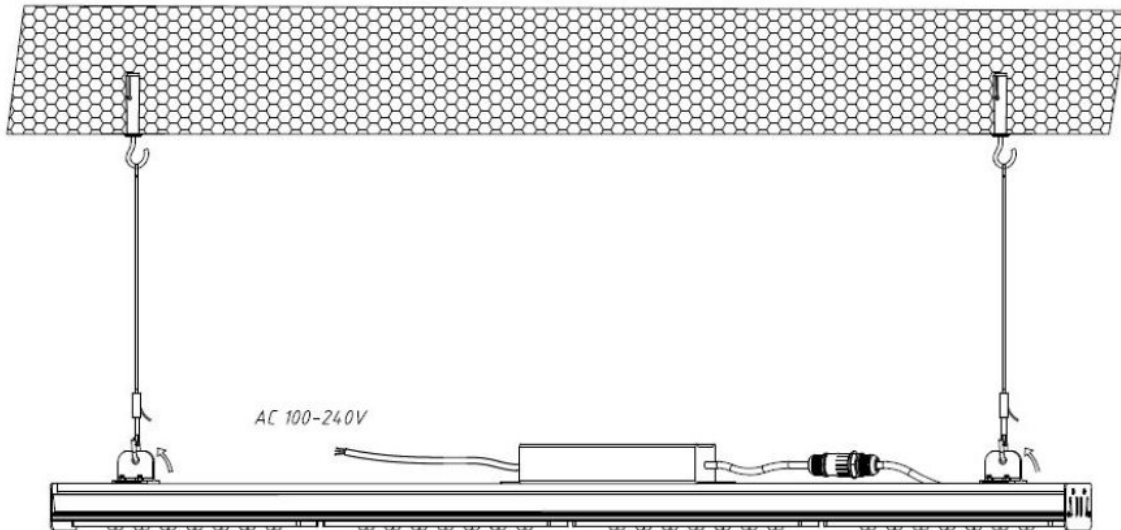

Application:

---



**RoHS**  
Compliant



**IP65**



50,000 hrs

